

# Data Sheet



Article number: 586351944

Description: Valve 351.944, G 1" - G 1"  
Thread/Thread

## Measures

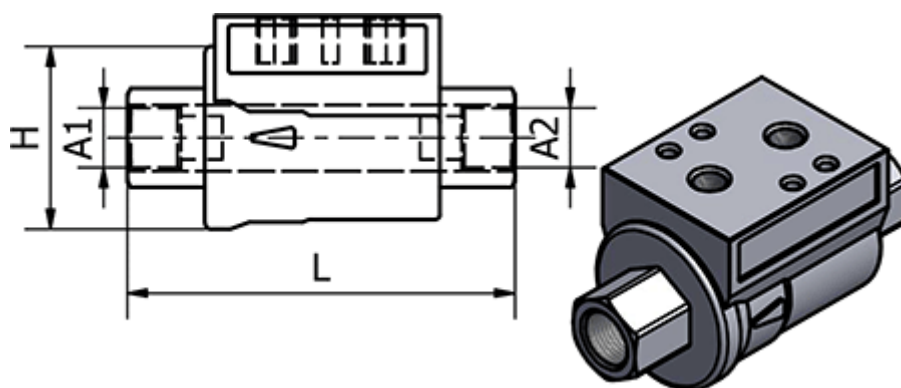

Connecting A1	= G 1"
Connecting A2	= G 1"
H	= 69
L	= 143
Max. Operating Pressure	= 10 bar
Seals	= NBR